

# Wequaquet Lake Beach and Bathhouse



## ADA Transition Plan

September 2021



Institute for Human Centered Design

www.IHCDesign.org • info@IHCDesign.org  
617-695-1225 voice/ tty

### Background

The Wequaquet Lake Beach and Bathhouse is located at 460 Shootflying Hill Road in Centerville. Amenities include a beach, a bathhouse, a picnic area, and a parking lot. The parking lot has 18 parking spaces including one (1) accessible space. In addition, a beach wheelchair is provided at this beach.

The bathhouse is located on the west side of the beach and consists of men's and women's multi-user toilet rooms. The men's toilet room has one (1) accessible urinal and one (1) accessible toilet compartment. The women's toilet room has two (2) compartments including one (1) that is accessible.

### Key Accessibility Issues

#### Exterior Accessible Routes

Accessibility issues include lack of a compliant ramp to the beach including lack of compliant handrails, lack of compliant landings and lack of edge protection. In addition, the portion of the ramp that extends to the beach area lacks handrails. Other accessibility issues include change in level at the walkway leading to the ramp and bathhouse, and a protruding concrete block on the path to the men's toilet room. Also, a route that extends to the recreation water level is not provided.

#### Parking Lot

Accessibility issues include a cross slope at the access aisle that is greater than the maximum allowed and lack of the designation "Van Accessible" at the accessible parking space.

#### Bathhouse

Accessibility issues include lack of compliant thresholds at the toilet room main entrance, toilet paper dispensers mounted above the side grab bars, mirrors higher than the maximum height allowed, lack of insulated pipes at the lavatories, lack of an accessible route to the urinal and coat hooks mounted higher than the maximum height allowed. Other accessibility issues in the women's toilet room include lack of a self-closing door at the

accessible compartment and lack of a door pull on both sides of the door near the latch.

### Additional Accessibility Issues

- Lack of handrail extensions at the stairs leading to the beach.
- Lack of designation signs with raised characters and braille at the toilet rooms.
- Lack of a compliant accessible portable toilet.
- Lack of accessible picnic tables.

**Note:** When providing picnic tables, ensure the required 19" knee clearance is provided. See fig. below.

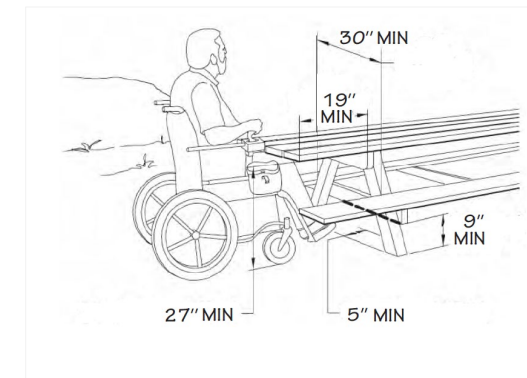

- Provide compliant handrails: \$2,640
- Provide a beach mat to the recreation water level: \$1,379
- Renovate toilet rooms: \$2,434
- Miscellaneous corrective actions (signage, parking, picnic tables, handrails, etc.): \$5,820

**Total: \$12,273**

**Note:** Cost to provide a compliant ramp is not included. Cost to provide a compliant portable toilet is not included.



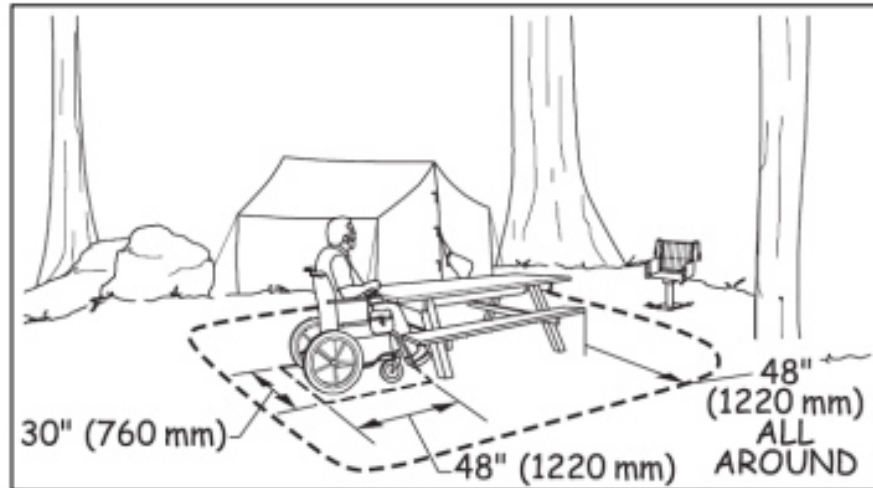

### Best Practice and Inclusive Design

Best practice and inclusive design recommendations include elements that are not required in the standards but may create enhanced experiences for all users.





- When an accessible picnic table is provided on an accessible route, IHCD recommends providing a stable, firm and slip-resistant surface for 48" clear on all sides of the picnic table. See fig. below.







**Town of Barnstable  
Wequaquet Lake Beach and Bathhouse**

ID	Location	Floor	Room	Element	Type	Photo	Issues	Current Measure	Recommendations	Quantity	Price	Cost Estimation
<b>Approach and Entrance</b>												
<b>Exterior Access Route</b>												
1	Towards Men's Toilet Room	Ext.		Exterior Access Route	Walkway		Route obstructed by protruding objects	-	Relocate concrete block to maintain the accessible route to the men's toilet room.	1	Labor	\$0
2	Route to Bath House	Ext.		Exterior Access Route	Walkway		Surface openings > 1/2"	2"	Repair surface. Cost for a 4'x4' concrete patch.	1	256	\$256
3	Route From Parking Lot to Lake	Ext.		Exterior Access Route	Exterior		Running slope > 1:20 (5%)	6.7%	Reduce running slope to be no steeper than 1:20 (5%).	1	-	\$0
4	Lake Front	Ext.		Exterior Access Route	Walkway		Level changes > 1/4"	11.5"	Alter change in level to provide a 1:12 (8.33%) max. slope that connects to a beach mat.  See ID #5 for mat cost.	1	-	\$0
<b>Beach Access Routes</b>												
5	Lake Front	Ext.		Beach Access Routes	Removable		Beach route not provided	-	Provide an accessible route that is firm and stable. Ensure the accessible route extends to the recreation water level .  (Cost for a beach mat that is 5 ft wide and 30 ft.)	1	1379	\$1379





**Town of Barnstable  
Wequaquet Lake Beach and Bathhouse**

ID	Location	Floor	Room	Element	Type	Photo	Issues	Current Measure	Recommendations	Quantity	Price	Cost Estimation
<b>Off-Street Parking Lot or Garage</b>												
6	Parking Lot	Ext.		Off-Street Parking Lot or Garage	N/A		Running or cross slope at access aisle > 1:50 (2.00%)	3.8%	Reduce running or cross slope to be no steeper than 1:50 (2.00%).	1	1440	\$1440
7	Parking Lot	Ext.		Off-Street Parking Lot or Garage	Visitor		Sign does not have the designation "Van Accessible"	-	Add the designation "Van Accessible" to the sign located at the van accessible space.	1	500	\$500
<b>Entrance</b>												
8	Women's Toilet Room	Ext.		Entrance	Main Entrance		Threshold not beveled Threshold is > 1/2" high	- 1"	Bevel threshold. Alter threshold to be 1/2" high max.	1	300	\$300
9	Women's Toilet Room	Ext.		Entrance	Main Entrance		Threshold not beveled Threshold is > 1/2" high	- 1"	See ID #8.	1	-	\$0
10	Men's Toilet Room	Ext.		Entrance	Main Entrance		Threshold not beveled Threshold is > 1/2" high	- 1"	Bevel threshold. Alter threshold to be 1/2" high max.	1	300	\$300





**Town of Barnstable**  
**Wequaquet Lake Beach and Bathhouse**

ID	Location	Floor	Room	Element	Type	Photo	Issues	Current Measure	Recommendations	Quantity	Price	Cost Estimation
11	Men's Toilet Room	Ext.		Entrance	Main Entrance		Threshold not beveled Threshold is > 1/2" high	- 1"	See ID #10.	1	-	\$0
<b>Access to Goods and Services</b>												
<b>Ramps</b>												
12	Route From Parking Lot to Lake	Ext.		Ramps	Exterior		Running slope >1:12 (8.33%)	10.2%	Reduce running slope to be no steeper than 1:12 (8.33%).	1	-	\$0
13	Route From Parking Lot to Lake	Ext.		Ramps	Exterior		Handrails have non-compliant cross section Edge protection < 4" high	- -	Provide handrails with 1-1/4" to 1-1/2" circular cross section. Provide edge protection that prevents the passage of a 4" diameter sphere, where any portion of the sphere is within 4" of the finished floor surface. (Recommendation applies to all the ramp runs.)	1	-	\$0
14	Route From Parking Lot to Lake	Ext.		Ramps	Exterior		Landing < 60" min. long	52"	Alter so the landing is 60" long min.	1	-	\$0
15	Route From Parking Lot to Lake	Ext.		Ramps	Exterior		Landing < 60" min. long	52"	Alter so the landing is 60" long min.	1	-	\$0





**Town of Barnstable  
Wequaquet Lake Beach and Bathhouse**

ID	Location	Floor	Room	Element	Type	Photo	Issues	Current Measure	Recommendations	Quantity	Price	Cost Estimation
16	Route From Parking Lot to Lake	Ext.		Ramps	Exterior		Landing < 60" min. long	52"	Alter so the landing is 60" long min.	1	-	\$0
17	Route From Parking Lot to Lake	Ext.		Ramps	Exterior		Handrails not provided	-	Provide handrails with 1-1/4" to 1-1/2" circular cross section.	2	1320	\$2640
<b>Stairways</b>												
18	Route From Parking Lot to Lake	Ext.		Stairways	Exterior		Handrails do not extend 12" from stairs	-	Top: Ensure handrails extend horizontally above the landing for 12" min. beginning above the first riser nosing. Bottom: Ensure that the sloped bottom extension extends one tread depth minimum beyond last riser nosing in same direction as stair flight.	2	200	\$400
<b>Signage</b>												
19	Women's Toilet Room	Ext.		Signage	Designation		Raised characters not provided Braille not provided	- -	Provide text with raised characters duplicated in braille.	1	232	\$232
20	Men's Toilet Room	Ext.		Signage	Designation		Raised characters not provided Braille not provided	- -	Provide text with raised characters duplicated in braille.	1	232	\$232

**Town of Barnstable  
Wequaquet Lake Beach and Bathhouse**



ID	Location	Floor	Room	Element	Type	Photo	Issues	Current Measure	Recommendations	Quantity	Price	Cost Estimation
<b>Picnic Tables</b>												
21	Bath House Picnic Table	Ext.		Picnic Tables	N/A		Toe or knee clearance at table not provided	-	Provide a picnic table with top between 28"- 34" above the ground and 27" clear height underneath.	1	1400	\$1400
22	Lake Front	Ext.		Picnic Tables	N/A		Toe or knee clearance at table not provided Picnic table not on an accessible route	- -	Provide at least one picnic table with top between 28"- 34" above the ground and 27" clear height underneath in this area. Ensure picnic table is on an accessible route.	1	1400	\$1400
<b>Toilet &amp; Bathing Rooms</b>												
<b>Overall Access</b>												
23	Women's Toilet Room	1		Overall Access	Toilet Room		Audible and visible alarms not provided	-	When fire system is updated, ensure that a visible and audible fire alarm is installed.	1	-	\$0
24	Men's Toilet Room	1		Overall Access	Toilet Room		Audible and visible alarms not provided	-	When fire system is updated, ensure that a visible and audible fire alarm is installed.	1	-	\$0
<b>Lavatory</b>												
25	Women's Toilet Room	1		Lavatory	N/A		Exposed plumbing underneath Mirror above lavatory w/reflective surface > 40"	- 48"	Insulate or otherwise configure pipes to prevent contact for at least one lavatory. Lower mirror so that the bottom surface is at 40" max. above the finished floor.	1	348	\$348

**Town of Barnstable  
Wequaquet Lake Beach and Bathhouse**

ID	Location	Floor	Room	Element	Type	Photo	Issues	Current Measure	Recommendations	Quantity	Price	Cost Estimation
26	Men's Toilet Room	1		Lavatory			Exposed plumbing underneath Mirror above lavatory w/reflective surface > 40"	- 48"	Insulate or otherwise configure pipes to prevent contact for at least one lavatory. Lower mirror so that the bottom surface is at 40" max. above the finished floor.	1	348	\$348
<b>Toilet Compartment</b>												
27	Women's Toilet Room	1		Toilet Compartment	Accessible Compartment		Door with malfunctioning self-closing hinge Coat hook > 48" Door pull not provided	- 63" -	Repair hinge. Lower coat hook so that it is no higher than 48". Provide a door pull on both sides of the door near the latch.	1	220	\$220
28	Women's Toilet Room	1		Toilet Compartment	Accessible Compartment		Non-compliant toilet paper dispenser	-	Relocate toilet paper so that it is located under the grab bar and higher than 15" above the finished floor; and between 7" and 9" from the front of the toilet.	1	256	\$256
29	Men's Toilet Room	1		Toilet Compartment	Accessible Compartment		Non-compliant toilet paper dispenser	-	Relocate toilet paper so that it is located under the grab bar and higher than 15" above the finished floor; and between 7" and 9" from the front of the toilet.	1	256	\$256
30	Men's Toilet Room	1		Toilet Compartment	Accessible Compartment		Coat hook > 48"	66"	Lower coat hook so that it is no higher than 48".	1	150	\$150



**Town of Barnstable**  
**Wequaquet Lake Beach and Bathhouse**

ID	Location	Floor	Room	Element	Type	Photo	Issues	Current Measure	Recommendations	Quantity	Price	Cost Estimation
<b>Urinal</b>												
31	Men's Toilet Room	1		Urinal	N/A		Urinal recessed > 24" has > 36" clear width	31"	If urinal is recessed greater than 24" ensure there is a clear width of 36". Recommend relocating the partition.	1	256	\$256
<b>Portable Toilet</b>												
32	Near Men's Toilet Room	Ext.		Portable Toilet	N/A		Accessible portable toilets not provided	-	Ensure that at least 5% of portable toilets are accessible.	1		\$0